

A GUIDE TO SAFER GAS FLUEING



PUBLISHED BY ABEY, OFFICE OF GAS SAFETY AND THE PLUMBING INDUSTRY COMMISSION

CONTENTS

THE PURPOSE OF GAS APPLIANCE FLUEING

- Simplified theory of flueing principles of twin skin (insulated) gas flue operation 2
- Evolution of the twin skin gas flue 3

SAFETY FEATURES OF TWIN GAS FLUE

- Fire prevention 4
- General rules for safe flueing 4

TWIN GAS FLUES VERSUS SINGLE SKIN 5

STANDARD INSTALLATION PROCEDURES

- Space heaters 6-7
- Water heaters 7
- Wall furnaces 8

SINGLE APPLIANCE FLUE SYSTEMS

- General rules 9
- Definitions 9
- How to use the single appliance flue table 9

TABLES 10

MULTIPLE APPLIANCE FLUE SYSTEM

- Definitions 11
- Flue connector size 11
- Common flue size 11, 12, 13
- Water heater flue connector size 11
- Furnace flue connector size 11

MANIFOLD FLUEING 14

MULTI-STOREY FLUEING

- Indirect and direct appliances 15
- Safety factors 15
- Separation 15
- Applying combined flue table to indirect appliances 16
- Applying individual flue table to direct appliances 17

SPECIFICATIONS AND DIMENSIONS

- Round 18, 19
- Oval 20, 21

IN THE INTEREST OF SAFER GAS FLUEING

Most gasfitters appreciate that it is essential for gas flueing to be installed to the correct standards to avoid reduced effectiveness of heating systems, gas wastage and safety risks. The Office of Gas Safety is committed to doing all it can to make it easier for gasfitters to achieve compliance with the Australian Gas Code and relevant Australian Standards. I commend Abey for their commitment to safer gas flueing, and urge you to follow the advice contained in these pages.

Ken Gardner
Director, Office of Gas Safety

Every one of Victoria's licensed gasfitters/plumbers needs to know the requirements of the Gas Installation Code and relevant Australian Standards. This guide provides a useful reminder of major provisions of the code and will be sent out to every one of Victoria's plumbers. I urge you to take advantage of the sound and practical guidance provided in this publication.

Michael Kefford
Plumbing Industry Commissioner

Abey Australia have been at the forefront of ensuring their customers are well equipped with not only quality gas and plumbing products, but the most up to date safety and installation information. For the last 20 years Abey have been publishing and distributing this important Gas Safety guide for gasfitters and plumbers, providing much needed safety and installation details to many of Australia's tradespeople. Abey would like to thank the Victorian Office of Gas Safety and the Plumbing Industry Commission for their ongoing support.

Geoff Anderson
Managing Director, Abey Australia Pty Ltd

THE PURPOSE OF GAS APPLIANCE FLUEING

Simplified theory of flueing and principles of twin skin (insulated) gas flue operation

Although gas is a clean-burning fuel its combustion products should not be allowed to accumulate in a residence or other building structure.

Some gas appliances are certified by the Australian Gas Association for use without flues but those which are certified for use with a flue must be properly flued, except in very rare circumstances where regulations permit otherwise. It is universally agreed that proper flueing should perform the following functions to ensure safe and dependable operation of the appliance.

- 1 Convey all the combustion products to outside atmosphere.
- 2 Protect the building structure from fire hazards resulting from the heat of the flue.
- 3 Prevent condensation of the water vapour present in the combustion products.
- 4 Provide fast priming of the flue to avoid spillage of the products into the room.

To understand the job which a flueing system must do, it is helpful to consider the quantities of gases that must be removed.

About ten cubic metres of air is needed to burn one cubic metre of natural gas in an appliance. The combustion products will consist of one cubic metre of carbon dioxide, two cubic metres of water vapour and eight cubic metres of nitrogen. The nitrogen is already present in the air and passes through the combustion process unchanged.

If the combustion products are not removed and replaced with fresh air, the oxygen in the air becomes depleted. The combustion process, deprived of sufficient oxygen, becomes incomplete and carbon monoxide may be produced. Present in even very small quantities, carbon monoxide can be lethal.

How does a flue work?

The principle on which a flue works is a simple one – heat. Heat can be said to be the power that operates a gas flue. Combustion gases rise in a flue only because they are hotter and therefore lighter than the surrounding air.

The hotter the gases are the more swiftly they rise in the flue, and conversely the cooler they are and more sluggish will be their movement until, if cooled enough, the upward motion stops altogether and combustion products spill out of the draught diverter and into the room.

Obviously the flue gases must be kept as warm as possible, but with the new energy efficient appliances, the intent is to extract as much heat as possible from the appliance. Therefore the flue gases are much cooler.

It can be seen that a gas flue must possess high insulating value so as to confine the heat inside it. A high insulating value greatly reduces heat loss through the flue wall and also prevents overheating of any nearby combustible materials.

Thus we have shown that to meet the first and second of the four fundamentals for proper flueing, a flue must possess high qualities of insulation.

The third requirement concerns the prevention of condensation in the flue. As we noted earlier, water vapour is a major combustion product. Experience has shown that it can be one of the most troublesome.

To solve this problem we again call on the magic ingredient heat. If the flue is adequately insulated it will confine heat inside the flue and the heated water vapour will pass harmlessly up the flue as a dry invisible gas. If allowed to cool below its dew point (40°C) problems will arise.



THE PURPOSE OF GAS APPLIANCE FLUEING

Example 1

A wall furnace which has a 30 MJ/h input burns 0.76 cubic metres of Natural Gas per hour. That amount of burnt gas will produce approximately 1.5 cubic metres of water vapour, or one litre if allowed to condense.

Example 2

A standard internal water heater which has a 34 MJ/h input burns 0.88 cubic metres of Natural Gas per hour. That amount of burnt gas will produce approximately 1.75 cubic metres of water vapour or 1.1 litres of water if allowed to condense. Thus we see another strong argument in favour of insulated flues.

The last requirement for an effective flue is that it becomes fully primed as quickly as possible after the appliance is turned on. Most people are familiar with old fireplaces that do not 'draw' until the fire has been blazing for some time. The same problem frequently occurs with uninsulated single wall flues, especially in colder weather.

The heat passes rapidly through the single wall to the surrounding air. The flue gases are cooled or even chilled by this heat loss. The flueing action becomes sluggish leading to spillage and condensation problems.

The easiest method of providing insulation is by using a twin wall flue. These flues are designed to minimise heat loss and therefore prime much quicker, eliminating the major cause of spillage and condensation.

We have now explained in the briefest detail the principles governing safe flue operation.



Evolution of the twin wall flue

(Excerpt from American Gas Magazine)

Some years ago it became apparent to gas utility companies and gas furnace manufacturers that the gas flue then in use did not satisfactorily meet performance requirements. Almost without exception they produced condensation damage or failed to completely remove all combustion products.

To solve these problems, a gas flue design was perfected which satisfied all these requirements. Laboratory tests indicated that the flue was sufficiently insulated to prevent all the problems associated with gas flueing. Further the flue offered excellent corrosion resistance.

Large scale field tests confirmed these findings and the double wall gas flue was born. Basically a pipe within a pipe, this double wall flue utilised the highly efficient principle of reflective insulation to produce a hotter inside, cooler outside flue. This characteristic alone solved many gas flueing problems. For the first time the gas industry had an approved gas flue which minimised condensation, which could be depended upon to operate efficiently and which offered substantial installation economies.

The double wall flues rapidly gained recognition. Such organisations as the American Gas Association, Underwriters Laboratories and the National Board of Underwriters quickly extended their acceptance of twin wall design. Today that acceptance extends to virtually every municipality in the United States, and a fine record of safe, trouble free operation has been built up over the last 30 years by double wall gas flues. In summation it should be stressed that double wall gas flues have achieved nationwide acceptance and usage because of their outstanding safety and performance record.



SAFETY FEATURE OF TWIN GAS FLUE

Fire prevention

Twin wall gas flues are specifically designed to provide an extra margin of protection against fire hazards. This is accomplished by a double wall, air insulated design, which confines heat where it belongs, inside the flue. Careful comparative tests have shown conclusively that twin wall flues have twice as much insulation value as single wall flues. This enormously increased insulation effectively protects walls, framing and partitions from the dangerous effects of overheating, and permits installation of the flue at 10mm clearance from combustible building or household materials. The superior safety of the twin wall flue is illustrated as follows. Research by AGA many years ago disclosed that gas wall heaters produced extremely hazardous temperatures around the flue when installed in stud walls. However, twin wall flues were found to be perfectly safe in such installations. It is now common practice to use twin wall flues with wall furnaces.

A word of explanation at this point regarding the ignition characteristics of wood. Once it was generally believed that a temperature of 260°C to 316°C was necessary to ignite wood. However, studies and experience have shown that wood in normal construction can ignite at much lower temperatures if the heat is applied over a number of years. A great number of laboratory experiments and field studies have been made on this subject and it has been confirmed that long time exposure of wood at low temperatures can result in spontaneous ignition. This process is known as pyrolysis. It was further noted that heat need not be applied continuously, instead it was found that intermittent exposure to moderate temperatures over a period of years was sufficient to produce spontaneous ignition of wood. Some observers in fact reported that ignition appeared to occur more frequently when heat was applied intermittently, as with thermostat controlled equipment, rather than continuously.



General rules for safer flueing

- An adequate supply of fresh air must be provided for combustion purposes and to ensure satisfactory operation of the flueing system.
Advice: Ensure adequate fresh air by installing permanent ventilation openings.
- When single wall flues are used the high heat losses can cause the gases to be cooled below dew point so that water condenses on the inside.
Advice: Install twin wall flue.
- Corrosion in the flue, draught hood or burners can cause malfunction of the appliance or flue system. Corrosion is always a symptom of some other problem and usually results from the presence of water. Continuous condensation that can occur in a single wall flue can cause rusting of the flue, cowl and appliance draught diverter to which the flue is connected.
Advice: Install twin wall flue.
- Spillage from an appliance draught diverter may cause condensation on windows or walls, or produce odours that the customer would notice. Spillage can be caused by an incorrectly sized flue, a blockage in the flue or down draught.
Advice:
 - Select the correct flue size.
 - Use an AGA approved flue cowl.
 - Avoid horizontal flue runs, ensure a minimum rise of 20mm/metre.
 - Minimise changes of direction, usually two 90° elbows can be tolerated, if more are required then the flue system should be re-designed. Use less restrictive bends where possible.
- If the flue cowl is located near a parapet, below the top of an adjacent building or the edge of a roof, it could be exposed to high pressure conditions. The high pressure may overcome the flue pull and upset the normal action, causing spillage.
Advice: Relocate the cowl by raising the flue so it is in the free flow of wind, away from obstructions and at least 500mm above the roof line.

TWIN WALL GAS FLUES VERSUS SINGLE WALL

- Single wall flue pipe is generally of thin gauge galvanised steel which possesses little insulating value and offers such limited corrosion resistance that it can only be used in accessible locations.
- It is known that condensation occurs in gas flues only if the flue gases are cooled below their dew point (40°C) and it has been shown that the heat loss in single wall flues is often sufficient to cause condensation and the impairment of draught.
- The elimination of single wall flues will prevent many problems including reducing fire hazards, preventing leakage resulting from corrosion failure of the flue, and reducing the possibility of flue gas spillage into the structure.
- Twin wall flues, because of their superior insulation, can be installed in heated or unheated areas alike and can freely pass through floors, ceilings, partitions, walls and roofs provided a 10mm clearance is maintained.
- Black EPDM rubber flashings can be used on twin wall flues. The more expensive red silicon flashings may be required on single wall flues.
- Installation time is often reduced by using twin wall flue.
- An oval to round twin wall adaptor can be installed in a flat roof, making it easier to flash the protruding round section above the roof line.
- Twin wall flue gives an added margin of safety when connected to an internal water heater installed in a cupboard.
- Twin wall flue is required to be approved by the AGA.

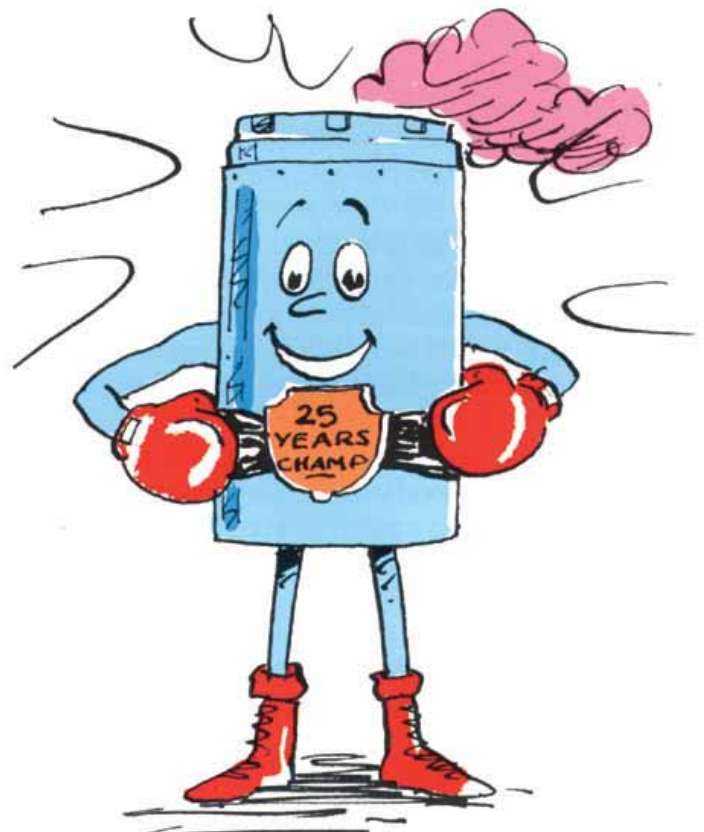
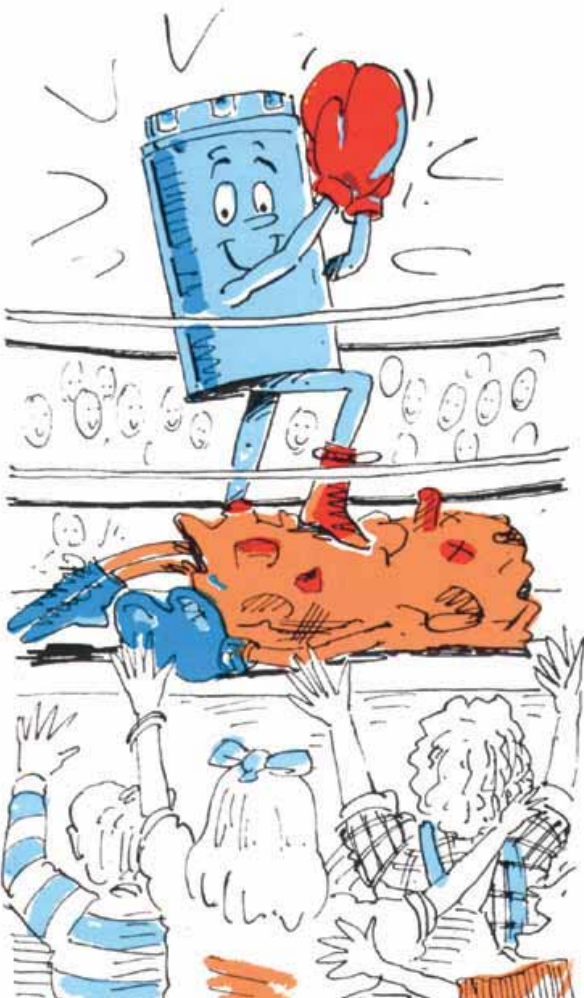

STANDARD INSTALLATION PROCEDURES

All appliances must be installed in accordance with the manufacturer's installation instructions, local gas fitting regulations, AS5601/AG601 Gas Installations, municipal building codes and any statutory regulations.

Space heaters

Installation procedure for fitting elbow housing and twin skin flue onto console or space heaters in walls of 90mm or greater.

- 1 Select studs between which heater is to be located. Maintain 350mm minimum to 560mm maximum between studs. Mark centre line.
- 2 Measure the distance from the floor to the centre line of the flue outlet on the rear of heater.
- 3 Mark on the plaster board the centre line and then cut opening in plaster board 350mm x 150mm as per Diagram 1.
- 4 Fit console elbow positioning hard against plaster in top of opening and secure as shown in Diagrams 2 and 3.
- 5 Cut top plate and remove any noggings. Then install top plate spacer.

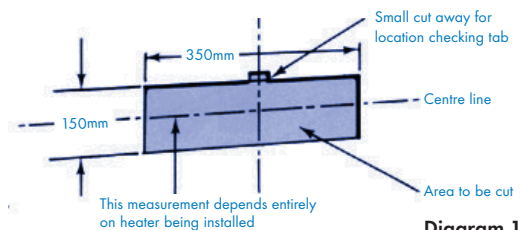

Diagram 1

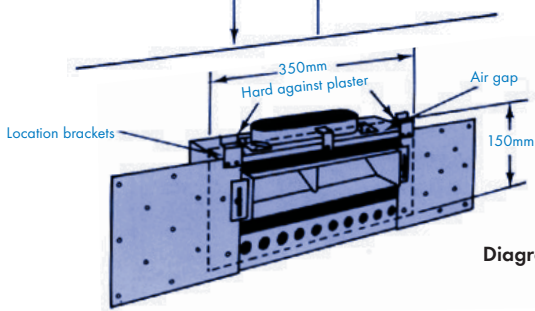

Diagram 2

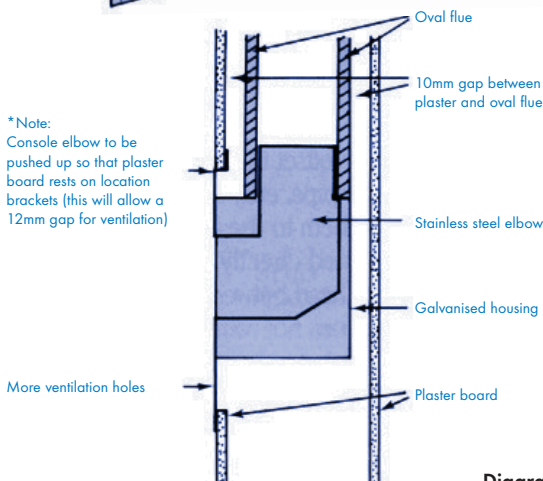
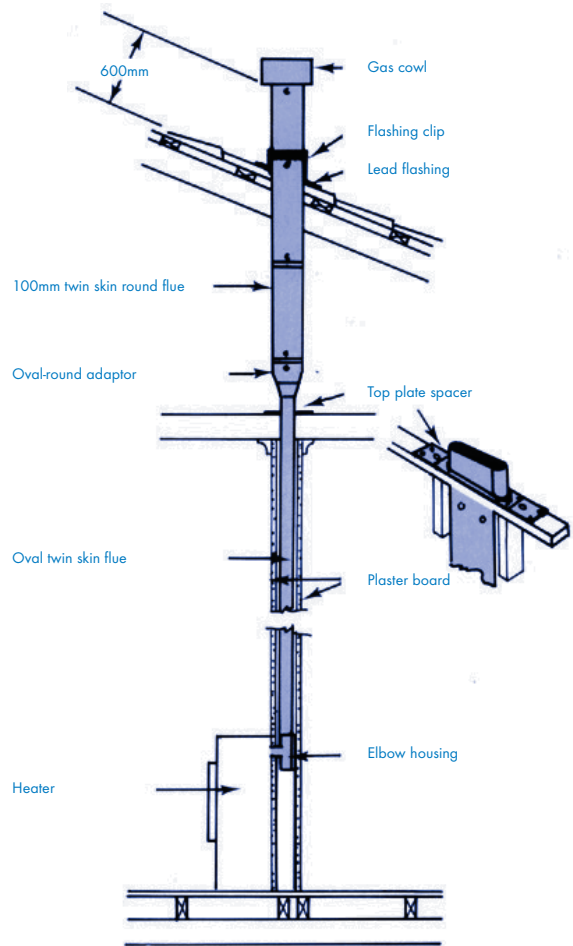

Diagram 3

IMPORTANT
Fit as shown ie fixed onto plaster board and not on to studs. You will have the correct clearance for your flue and adequate ventilation.

- 6 Select appropriate lengths of oval flue and insert down wall cavity on to elbow housing.
- 7 Engage locking tab in elongated slot in oval flue and tighten.
- 8 Place top plate over the oval flue and nail to top wall plate. Adjust location brackets to hold flue central and secure.
- 9 Fit oval-round adaptor then fit appropriate length of twin skin 100mm round flue, keeping a minimum of 600mm above roof.
- 10 Fit 100mm gas cowl.
- 11 Adjust height of stainless steel elbow to suit appliance by means of the two screws provided.
- 12 Fit heater against wall, making sure outlet is fully engaged in stainless steel elbow.
- 13 Follow manufacturer's instructions regarding fixing of appliance.

*For a standard 2440mm (8 foot) ceiling 1950mm of oval flue is required. 1500mm oval flue plus 450mm oval flue equals 1950mm. When joining two lengths of oval ensure spacers are used.



Correct installation for 90mm stud wall

STANDARD INSTALLATION PROCEDURES

Correct installation of heater in existing fireplace

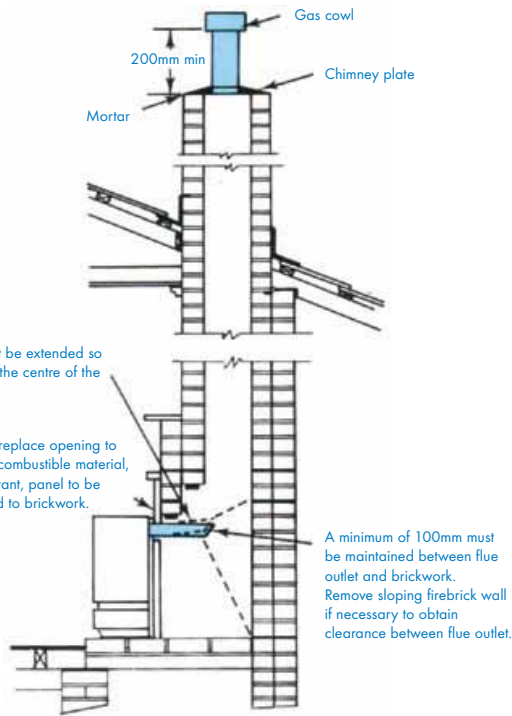

Installation procedure for flueing through an exterior wall

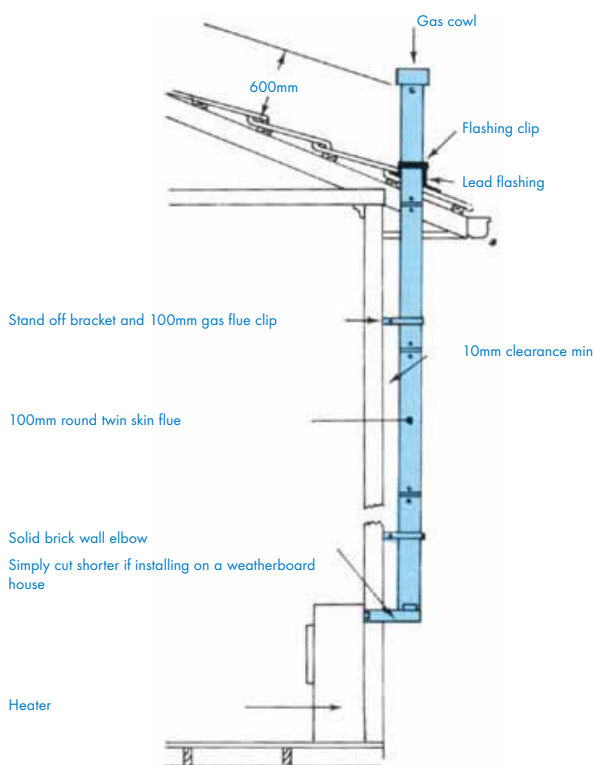

Installation proca water heater

- 1 Position appliance according to appliance manufacturer's instructions.
- 2 Drop a plumb line from ceiling or roof to centre of diverter to determine position of hole to be cut. Mark.
- 3 Cut opening in the ceiling and/or roof large enough to allow the required 10mm minimum clearance from the flue pipe to the wood members.
- 4 Slide diverter connector with single-wall end up, into 300mm adjustable pipe approximately half way, then install into the draft hood diverter. This enables you to remove the appliance without disturbing the flue and roof flashing, then begin installing pipe sections by joining the male end of one pipe to the female end of the next; twist to lock.
- 5 If the flue must be offset to clear obstruction (joist, gas or water pipe etc.) use two adjustable 45° elbows and twist them to the angle required. The elbows may be joined directly together or a length or more of pipe placed between them. NOTE: If your installation does not require an offset the elbows may be rotated to be used as approximately 140mm lengths of straight pipe.
- 6 Continue assembling pipe sections, until the flue extends through the roof a sufficient distance to conform to local codes.
- 7 Flash flue pipe to roof in approved manner.
- 8 Fit approved cowl using adaptor where required.

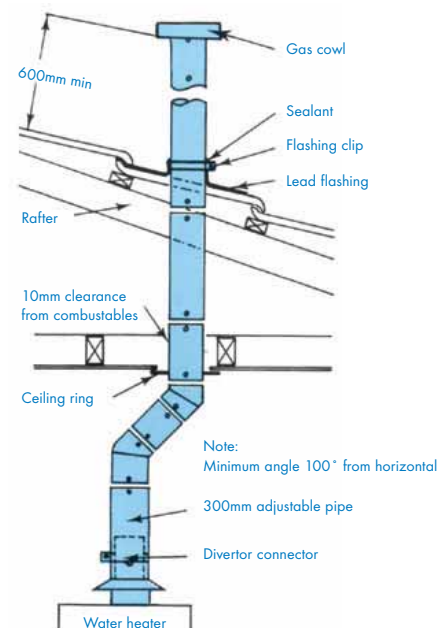

STANDARD INSTALLATION PROCEDURES

Wall furnaces

Installation procedure for fitting flue onto inbuilt wall furnaces in walls of 90mm or greater.

- 1 Install base plate as per manufacturer's instructions.
- 2 Bend header plate to suit opening between studs keeping front flush with frame. Nail securely in place.
- 3 Connect length of twin skin oval flue to spigot adaptor and position onto header plate. Select correct length of oval flue to protrude through top plate.

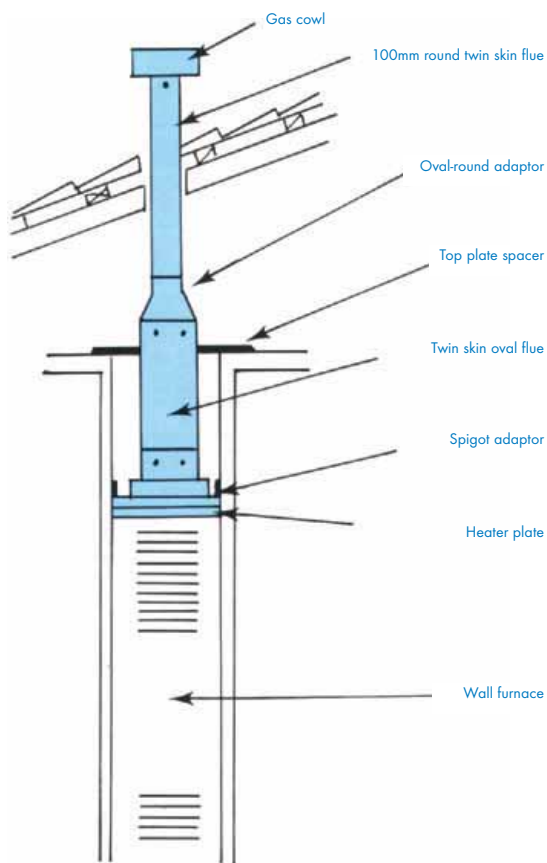

- 4 Place top plate over the oval flue and nail to wall top plate. Adjust location brackets to hold flue both central and secure.
- 5 Fit oval-round adaptor, then fit appropriate length of twin skin 100mm round flue, keeping a minimum of 600mm above roof.
- 6 Fit 100mm gas cowl.
- 7 Insert appliance as per manufacturer's instructions.

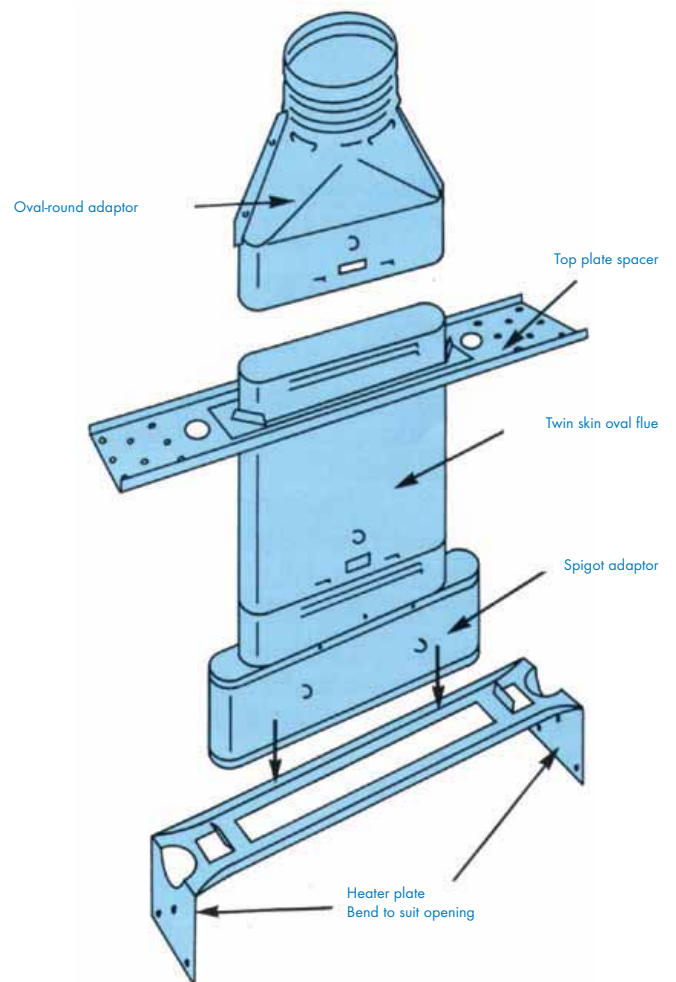

SINGLE APPLIANCE FLUE SYSTEM

A-1 General rules for flueing single appliances

Normally, a flue equal to the size of the draught hood outlet is satisfactory for flueing a single appliance. However, if the flue size determined from the tables is less than the size of a draught hood outlet the smaller flue may be used as long as the flue is at least 3 metres high. Regardless of the size of flue shown by the tables for such appliances, do not connect any 100mm draught hoods to a 75mm flue. Use the procedures in A-3 below to determine flue size.

Flues for draught hoods 300mm in diameter or less should not be reduced more than one pipe size. A 150 to 125mm or a 300 to 250mm reduction is a one pipe size reduction. For larger gas burning equipment, having draught hood sizes from 350 to 600mm in diameter reductions of more than two pipe sizes are not recommended. (600 to 500mm is a two size reduction.)

A-2 Definitions

Single appliance flue: An independent flue for one appliance.
 Total height (H): The total vertical distance measured between the draught hood outlet and the flue termination. (See Figure 1.)
 Total lateral length (L): The horizontal distance or length of offset between the draught hood outlet and the main vertical position of flue. (See Figure 1.)

A-3 How to use the single appliance flue table

To determine the proper flue size for a single appliance flue use the Single Appliance Flue Table (page 10, Table 1) as follows:

- 1 Determine total height (H) and total lateral length (L) of the flue.
- 2 Read down the total height (H) column at the left to find the proper total height.
- 3 Select the horizontal row for the appropriate length of lateral (L) (zero for straight vertical flues).
- 4 Read across the column which shows a capacity equal to or greater than the appliance nameplate MJ/hr input.
- 5 If the flue size shown at the base of the column containing the correct capacity is equal to or larger than the appliance draught hood, use the flue size shown by the Table.
- 6 If the flue shown is smaller than the draught hood size, see Section A-1 above.

A-4 Example

A typical individual flueing example is shown in Figure 2. The appliance has an input of 158 MJ/hr and a 150mm draught hood, a total flue height of 6 metres with a 3 metre lateral.

Procedure

- 1 Refer to the Single Appliance Flue Table 1 (page 10).
- 2 Go down the total height (H) column to the 6m line. Go across on the 3m lateral (L) line.
- 3 158MJ/hr capacity is found in the 125mm flue size column:

TOTAL FLUE HEIGHT (H)	LENGTH OF LATERAL (L)	FLUE SIZE (mm)		
		75	100	125
	0	64	126	213
	0.6	54	106	175
6m	1.5	51	101	169
	3.0	46	94	158
	4.5	41	89	151

- 4 A 125mm flue size is adequate, even though the appliance has a 150mm draught hood, because the total height exceeds 3m. (See Section A-1.)

A-5 Example

In Figure 3 we have the same appliance with a total flue height of 4.5 metres with a 4.5 metre lateral.

Procedure

- 1 Refer to the Single Appliance Flue Table (page 10).
- 2 Go down to the total height (H) column to the 4.5m line. Go across on the 4.5m lateral (L) line.
- 3 158 MJ/hr capacity is found in the 150mm flue column.

Figure 1

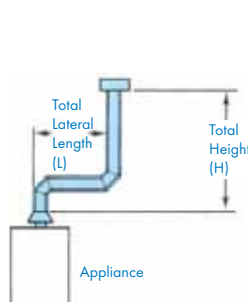

Figure 2

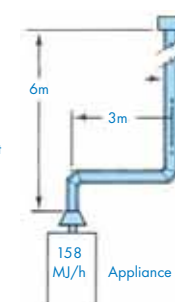
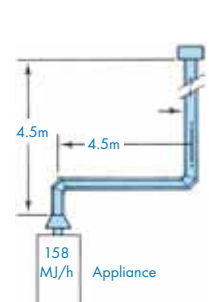

Figure 3



MULTIPLE APPLIANCE FLUE SYSTEM

B-1 Definitions

Multiple appliance flue: Any flueing system combining the connectors of two or more appliances at one floor level, attached to a common flue.

Minimum total flue height: The vertical distance from the highest appliance draught hood outlet in the system to the top of the flue. This becomes the governing minimum height dimension for the system, regardless of the number of appliances involved or their placement. (See Figure 5, page 12.)

Connector rise: The vertical distance from any appliances draught hood outlet to the lowest point where the flue connector joins the system. (See Figure 5.)

Common flue: That portion of the flueing system above or past first interconnection. When the common flue is entirely vertical it is called a vertical or 'V' type. Otherwise the common flue is a lateral or 'L' type (See Figure 4 for illustrations of both types.)

B-2 How to determine each flue connector size

Caution: Never use a connector smaller than the draught hood outlet size.

- 1 Determine the minimum total flue height for the system.
- 2 Determine the connector rise for each appliance.
- 3 Refer to the Flue Connector Table 2 (page 10) as follows:
 - a Refer to the least total height column.
 - b Use line giving least total height equal to or less than that determined for system.
 - c On same line, refer to connector rise designations; use line equal to or higher than rise for appliance.
 - d Continue across this line until you reach a column giving an MJ figure equal to or next higher than the MJ rating of the applicable appliance.
 - e Read the connector flue size for the appliance at the bottom of this column. (See Example B-4.)
- 4 Repeat the above procedure for each appliance in system.

B-3 How to determine common flue size

- 1 Total all appliance MJ input ratings.
- 2 Refer to Common Flue Table 3 (page 10), using the same minimum total flue height as in Section B-2 above.
- 3 Continue across either on the 'L' (lateral) line or on the 'V' (vertical) line, whichever is appropriate.
- 4 Select the first value which is equal to or greater than the total MJ rating for the system.
- 5 The size of the flue at the bottom of this column is the common flue size to use subject to the following:

Caution: Regardless of table results, the common flue must always be at least as large as the largest connector. If both connectors are the same size, the common flue must be at least one size larger.

B-4 Example

A typical multiple appliance flueing example is shown in figures 5-A, 5-B and 5-C: Connect a 46 MJ/hr water heater with a 0.3 metre connector rise and a 100 MJ/hr furnace with a 0.6 metre connector rise to a common flue with a minimum total flue height of 4.5m.

The three-step procedure for working this example is as follows:

(A) Determine water heater flue connector size

(See Figure 5-A)

Procedure

- 1 Refer to Flue Connector Table (page 10).
- 2 Read down least total height column to 4.5. Read across 0.3 connector rise line to MJ rating equal to or higher than water heater input rating.

LEAST HEIGHT TOTAL	CONNECTOR RISE (m)	FLUE SIZE (mm)		
		75	100	125
	0.3	32	56	88
4.5	0.6	37	66	104
	0.9	42	75	117

The figure shows 46MJ and is in the column for 100mm connector.

- 3 Since this is in excess of the water heater input, use a 100mm connector.

(B) DETERMINE FURNACE FLUE CONNECTOR SIZE

(See Figure 5-B)

Procedure

- 1 Refer to Flue Connector Table 2 (page 10).

LEAST HEIGHT TOTAL	CONNECTOR RISE (m)	FLUE SIZE (mm)		
		75	100	125
	0.3	32	56	88
4.5	0.6	37	66	104
	0.9	42	75	117

- 2 Read down least total height column to 4.5. Read across 0.6m connector rise line. 125 flue size shows 104 MJ/hr (same as furnace input).

- 3 Use a 125mm connector.

MULTIPLE APPLIANCE FLUE SYSTEM

Figure 4

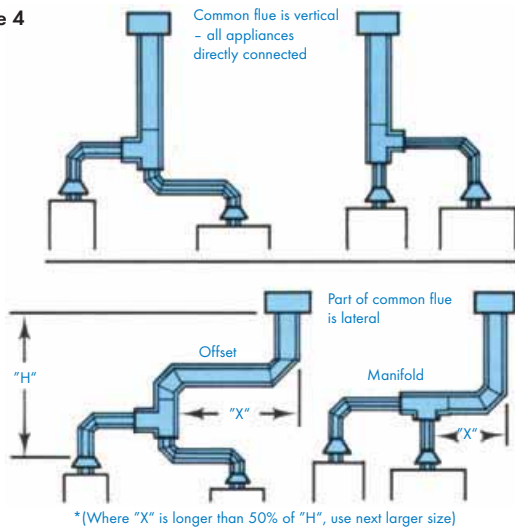

Figure 5-A

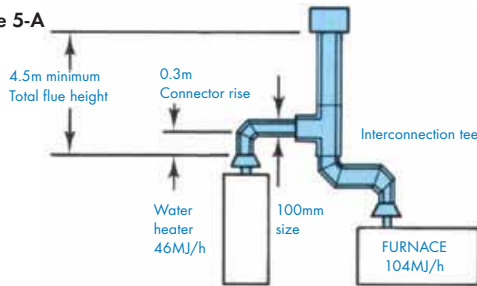

Figure 5-B

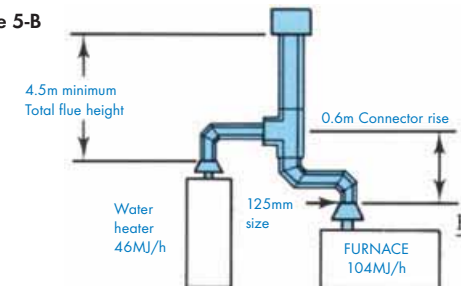
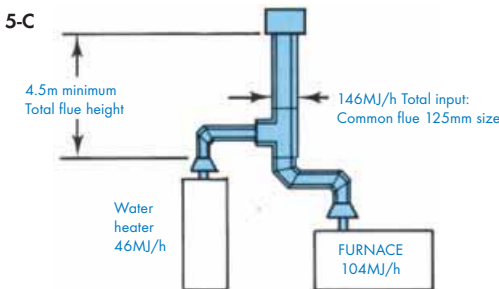

Figure 5-C



(C) Determine common flue size

(See Figure 5-C)

Procedure

- 1 Refer to Common Flue Table 3 (page 10).

LEAST TOTAL HEIGHT	FLUE TYPE	FLUE SIZE mm		
		75	100	125
4.5	L	-	77	120
	V	-	96	152

- 2 The total input to the flue is 150MJ/hr. The flue goes straight through roof so use 'V' (vertical) line.
- 3 4.5 metre maximum MJ/hr for 125mm flue is 152MJ. Therefore, the common flue can be 125mm diameter.

Additional guides for multiple appliance flueing flue connector lengths and capabilities

In order to use flue connector capacities from tables the entire connector must be twin skin and the length should not exceed the maximum length limit for its size as given below.

Size:	75	100	125	150	200	250	300	350	600
Length (metre):	1.5	1.8	2.4	3.0	3.6	4.5	5.5	6.0	9.0

Note: Doubling the length of a flue connector reduces its capacity by 10%. This rule should be applied whenever longer connectors must be used in applications where it is necessary to locate the appliance a distance greater from the common vertical flue than lengths shown in the table.

Use available headroom for maximum connector rise

Always use available headroom for maximum connector rise after allowing for the listed clearance to combustible. Obtain maximum connector rise by such methods as extending the connectors between the floor joists. The greater the connector rise, the greater the flueing power and efficiency of the system, permitting reduction of flue and connector sizes.

For economy, consider all alternatives

It is important in a combined flue system that the cost of individual versus combined flues be considered, especially if the system is short or many fittings are needed. Frequently, individual flues will prove more economical than a combined system.

MULTIPLE APPLIANCE FLUE SYSTEM

Figure 6

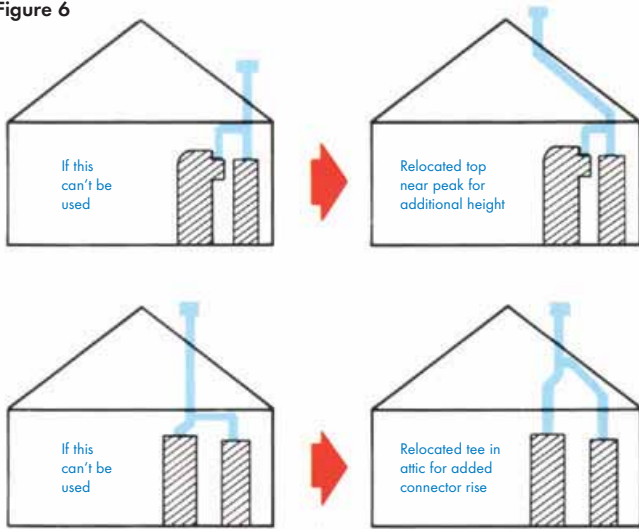

Figure 7

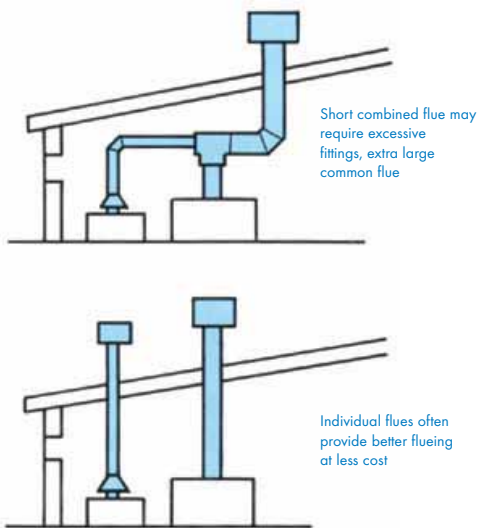
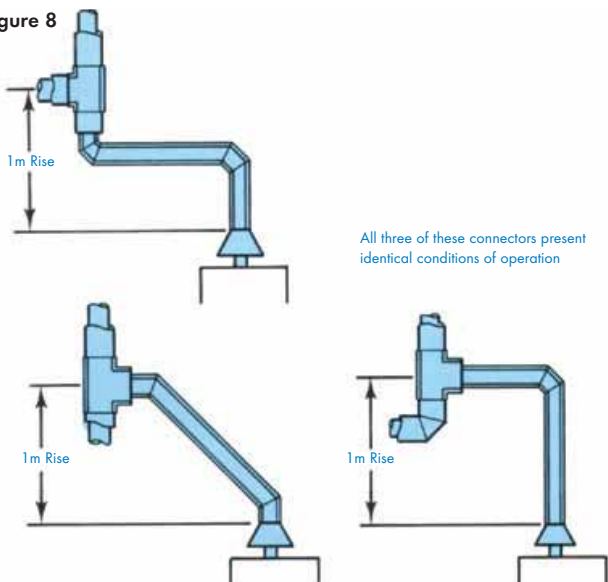

Figure 8



Redesign combined flue when adding appliances

If additional appliances are to be connected to an existing combined flue system, the entire system should be recalculated. Remember to consider these three factors:

- 1 minimum flue height;
- 2 all connector rises;
- 3 common flue capacities.

Use Multiple Appliance Flue Tables for these calculations as previously outlined.

Note: The flue tables may be used for any number of appliances up to 8 in combination or manifolded at one floor level.

Self flueing connectors sized from single appliance flue tables

When a flue connector as a part of a combined flue system has a rise of 1.5m or more it can be installed as though it were an individual flue by using the appropriate single appliance flue tables. It is important when sizing self-flueing connectors that allowances be made for lateral length and the number of turns.

When in doubt use one size larger flue

It is not possible to anticipate an installation or operational contingencies in designing a flue system. A good rule is, when in doubt use one size larger connectors and common flue than required by the flue tables.

Size of interconnection tees

Interconnection tees must be the same size as the common flue as shown in Figure 9.

Figure 9

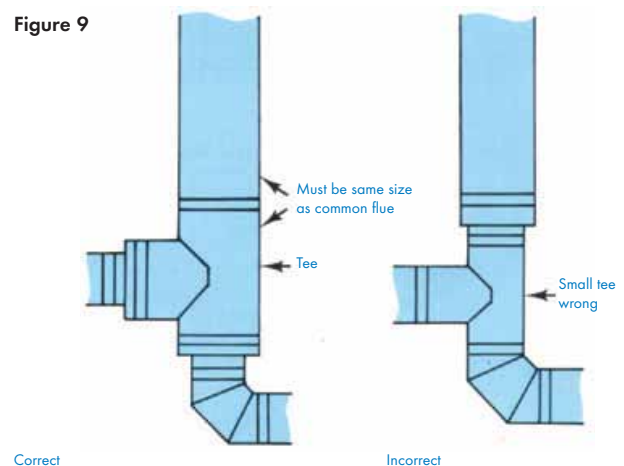

MANIFOLD FLUEING

1 Use 'L' inputs for manifold sizing

A manifold is a flue system which is a horizontal extension of the lower end of a common flue (see Figures 10 and 11 for typical examples).

The connection of a manifold to a common flue may be made by either a 90° elbow or a tee.

A manifold must be sized as a common flue for the combined total capacity and applicable total height.

Capacity of the manifold and common flue must be determined from the 'L' lines of the Common Flue Table 3 (page 10).

2 Horizontal versus sloped manifolds

(See Figure 10)

Excessively sloped manifolds do not improve flueing. Since proper connector rise is necessary for all appliances, a sloped manifold may result in draught hood spillage as shown in Figure 10.

Caution: Where local code requires sloped manifold, be sure that all connectors have a minimum rise in accordance with the Flue Connector Table.

3 Manifold connectors

Flue connectors from a group of appliances on one level may enter from below or from the side of the manifold. In either case the connector rise should be measured as the vertical distance from the draught hood outlet to the lowest level at which the connector enters the manifold.

Caution: Care must be taken in designing these systems because heat loss is apt to be great, with accompanying capacity reduction. This is especially true when dealing with connector turns and lengths.

4 Tapered or constant size manifolds

(See Figure 11)

There are two types of manifold flueing – tapered and constant.

Figure 10

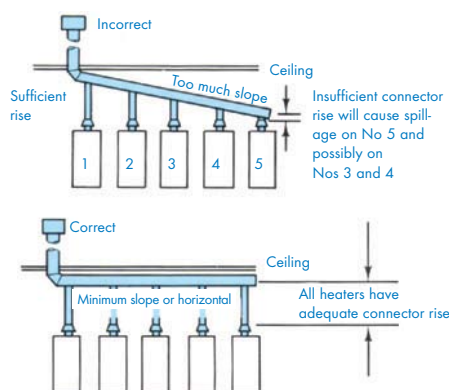

Tapered: This type uses the total heat input to each portion of the manifold (see Figure 11). Use 'L' capacities from Common Flue table 3 (page 10) for total height.

Note: Each section, as in Figure 11, is sized to include combined inputs of previous section.

Constant size: This type utilises a manifold and common flue of one constant size as determined from the 'L' capacities of the Common Flue Table 3 (page 10) using total system input and height. Either type of manifold is acceptable. A choice can be made on the basis of cost and convenience.

5 Manifold appliances operated by single control

Groups of boilers or other appliances attached to a flue manifold are frequently all operated simultaneously from a single control. Here is a design possibility for such a system: When one or more appliances can be turned off during periods of reduced heat demand, all connectors must conform to combined requirements. The manifold must be sized using 'L' common flue capacities.

6 Number of manifold appliances

Capacities for systems comprising as many as eight identical manifolded appliances are covered in the Connector and Common Flue Tables here again, adequate connector rise is essential to prevent draught hood spillage. The rise of the smallest connector must be increased when its draught hood area is less than one-seventh of the combined draught hood areas of other connected appliances.

7 Manifold lengths

Excessive manifold length may result in poor flueing. Therefore, manifold lengths should be limited to 3 metres or 50% of the total flue height; whichever is greater. Twin skin flue should be used in the entire manifold to obtain full rated capacities.

Figure 11

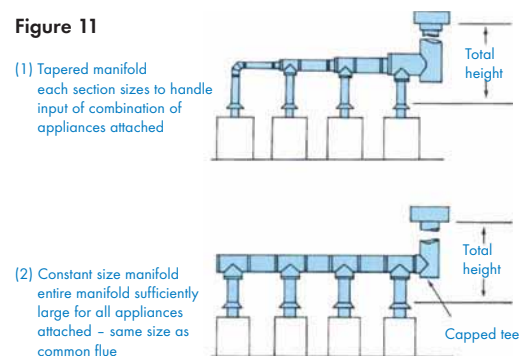

MULTI-STOREY FLUEING

Indirect and direct appliances and locations

Two types of gas appliances are served by a multi-storey flue system:

- 1 Indirect appliances: Those separate or remote from occupied areas. Boilers in basements, forced air furnaces, and water heaters in closets are examples.
- 2 Direct appliances: Those located in occupied areas room heaters, recessed heaters, furnaces and decorative appliances, such as gas-burning fireplaces, are examples.

Safety factors to consider

Three safety factors should be kept in mind when designing a multi-storey flue system.

- 1 Separation: For separation use indirect appliances within a room having access solely from an unoccupied space such as a hallway, service area or balcony. A solid door between appliance room and access area is acceptable although an outside entrance is preferable.
- 2 Air supply: No ventilation or combustion air should be taken from inhabited or occupied spaces within the building. Bring outside air into appliance room via louvers, ducts and air wells or chases.
- 3 Flue design: Be sure to follow design recommendations contained in this and preceding sections - they have all been tested and proved sound.

Separation

The separation of gas equipment from occupied spaces resolves the question of safety arising from intercommunication of flues between various levels of a building. Separation ensures that no flue products or flue gases can enter the building from the equipment room in the remote case that the common flue becomes obstructed at any level or the outlet is blocked. When such stoppage occurs, all flue gases from appliances operating below the obstruction will exit through the louvers rather than through the flue outlet. Large quantities of flue products will be dumped into the space containing those appliances immediately below the obstruction, while, at the same time, appliances at lower levels will appear to be operating normally.

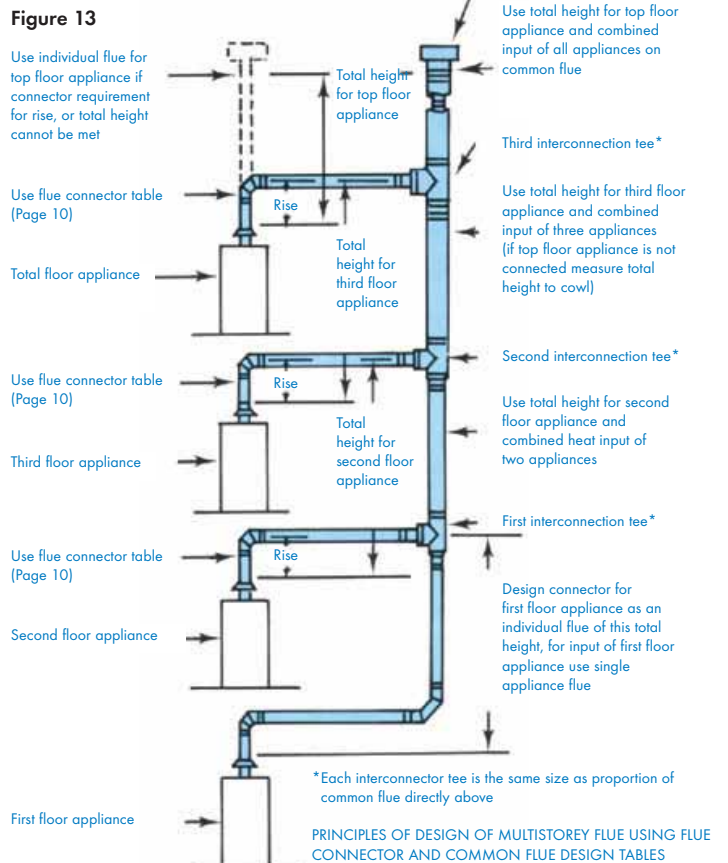
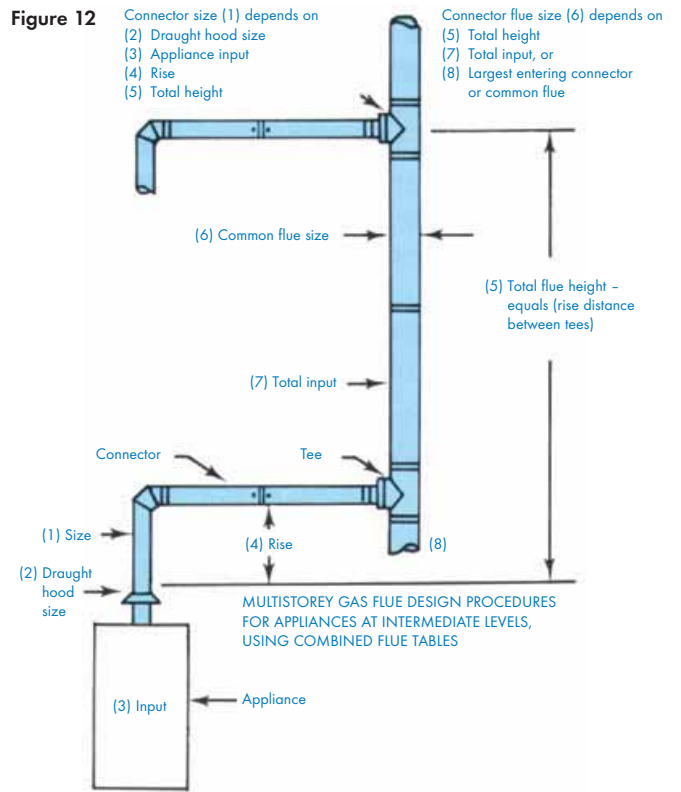

MULTI-STOREY FLUEING

Applying combined flue tables to indirect appliances

The following general design method for multi-storey flues uses the Combined Flue Tables and is best suited to indirect appliances. As with simple combined designs the common flue and connector rise must act jointly to flue all attached appliances without draft hood spillage. Because this independence results in a smaller vertical common flue the flow rate and flue products disposal capacity may be somewhat less by comparison than completely self-flueing connectors.

Design principles

Any height of multi-storey flue serving multi-level appliances may be designed using the Flue Connector and Common Flue Tables (page 10). The resulting flue system functions properly when any or all appliances are operating. Figures 12 and 13 illustrate typical multi-storey flue configurations. Study both illustrations carefully. When designing a multi-storey flue system the following principles should be applied.

- 1 The overall system should be divided into smaller, simple combined flue systems for each level, each using a minimum total flue height for each level as illustrated in Figure 12.
- 2 Each flue connector from the appliance to the vertical common flue should be designed from the flue connector table as in multiple appliance flue systems.
- 3 For sizing of the vertical common flue, the Common Flue Table is used. The vertical common flue for each system must be sized large enough to accommodate the accumulated total input of all appliances discharging into it, but should never be smaller in diameter than the largest section below it.
- 4 The flue connector from the first floor or the lowest appliance to the common flue is designed as if terminating at the first tee or interconnection. The next lowest appliance is considered to have a combined flue which terminates at the second interconnection. The same principle continues on to the highest connecting appliance with the top floor appliance having a total flue height measured to the outlet of the common flue.
- 5 The multi-storey system has no limit in height as long as the common flue is sized to accommodate the total input.

Precautions in designing multi-storey flue systems

- 1 Common flue height must always be computed as the distance from the outlet from the draught hood to the lowest part of the opening from the next interconnection above.

- 2 If the connector rise is inadequate, increase connector size, always making use of maximum available connector rise.
- 3 Be sure that the air supply to each appliance is adequate for proper operation. A separation of appliance rooms from occupied area and provision for outside air supply is necessary.
- 4 If an air shaft or chase is used for installation of the common flue, be sure that sufficient space is provided for fittings, clearance to combustibles and access for proper assembly.
- 5 The capacity tables apply only when the entire system is constructed of twin skin flue.

Example

Figure 13 shows a typical example of a multi-storey vent system.

- A Assume Figure 13 represents a 4-storey building.
- B Each appliance has 95 MJ/hr input.
- C Each appliance has a 125mm draught hood.
- D Minimum total vent height is 3 metres for each of the three lower floors.
- E Minimum total vent height is 2 metres for the top floor.
- F The common flue is vertical so use the 'L' section of the Common Flue Table (page 10) for figuring common flue size.

The following table shows the calculations for flueing all four floors into the common flue.

APPLIANCE	TOTAL INPUT TO COMMON FLUE	AVAILABLE CONNECTOR RISE	MIN TOTAL FLUE HEIGHT	CONNECTOR SIZE	COMMON FLUE SIZE
1	95 MJ/hr	3.0m	3.0m	125mm	self-flueing connector
2	190 MJ/hr	0.3m	3.0m	50mm	175mm
3	285 MJ/hr	0.3m	3.0m	150mm	200mm
4	380 MJ/hr	0.3m	3.0m	150mm	250mm

However, if the heater on the top floor is flued separately, the following table shows the result of increasing the minimum total flue height of the third floor appliance to 4.5m and decreasing total input to common flue to 285 MJ/hr per hour.

APPLIANCE	TOTAL INPUT TO COMMON FLUE	AVAILABLE CONNECTOR RISE	MIN TOTAL FLUE HEIGHT	CONNECTOR SIZE	COMMON FLUE SIZE
1	95 MJ/hr	3.0m	3.0m	125mm	self-flueing connector
2	190 MJ/hr	0.3m	3.0m	150mm	175mm
3	285 MJ/hr	0.3m	4.5m	150mm	175mm
4	95 MJ/hr	2.4m	2.0m	125mm	self-flueing connector

The second table indicates the economics of flueing the top floor separately which eliminates the larger sizes of flue pipe and the use of extra, costly fittings.

MULTI-STOREY FLUEING

Applying individual flue tables to direct appliances use of oversize common flue

A solution for the multi-storey flueing of direct heaters is the use of an oversize common flue of constant diameter, which is provided with a sealed cleanout trap below the lowest connected appliance. (See Figure 14.)

All appliance connectors leading to such common flues are designed as individual flues. They will thus be self-flueing and will not need added draught from the common flue. The common flue then acts as an air shaft, receiving and carrying away all flue gases but not having to aid the operation of the connectors. It should be large enough so that small objects drop past the entry of the lowest connector to the bottom trap. Such a common flue will minimise the likelihood of debris blockage at any intermediate level.

While providing the above safety margin, a large common flue introduces the possibility of some vent gas condensation due to its excessive surface area. All parts of the system must be twin skin construction to help maintain the gases above their condensation temperature.

Self-flueing connectors for direct appliances

The two appliances most likely to be encountered in direct heating locations are space heaters and flued recessed wall furnaces. Take these precautions in the design of multi-storey vents for direct appliances.

Space heater connectors should be self-flueing

- A Increase the input 40% for purposes of designing the flue system.
- B Refer to individual flue table and design every connector as individual flue of 2m minimum height.
- C Use input for appropriate length of lateral. Do not use zero length of lateral input because the gases make one or more turns to enter the common flue.

Recessed heater connectors should be self-flueing

- A Increase the input 40% for purposes of designing the vent system.
- B Design every connector as individual flue of 2.1m minimum height.
- C Use input for individual flue with appropriate length of material.

Forced air furnaces, boilers, water heaters

When installed as direct appliances, design the connector for nameplate input. Connector rise should be at least 1.5m.

Common vertical flue serving direct appliances in occupied space

- A Find total of inputs of all appliances connected to common flue.
- B Use the common flue total height equal to distance between floors (or between successive connections if appliances are not connected at every floor).
- C Enter the Common Flue Table at total height and read across to 'V' capacity equal to or greater than total input.
- D Read to size of common flue shown for this capacity.
- E Install common vertical flue of this size starting at floor level of lowest connected appliance.
- F Immediately upon completing installation of entire height of vertical common flue, check for presence of debris inside, clean out if necessary, and install cowl.

Multiple appliances using self-flueing connectors

No limit is placed on the number of appliances or flue connectors attached to a common multi-storey flue of adequate size if all such connectors are self-flueing.

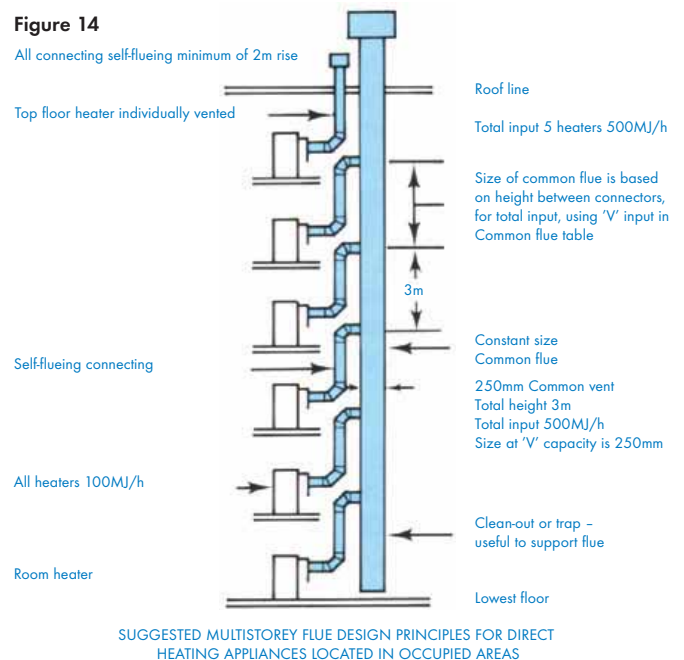



SPECIFICATIONS & DIMENSIONS FOR
ABEY ROUND TWIN SKIN GAS FLUE

Manufactured with an aluminium inner pipe and a galvanised outer pipe – all diameters are inside dimensions

Abey round pipe and fittings use the simple 'push-twist-lock' principle

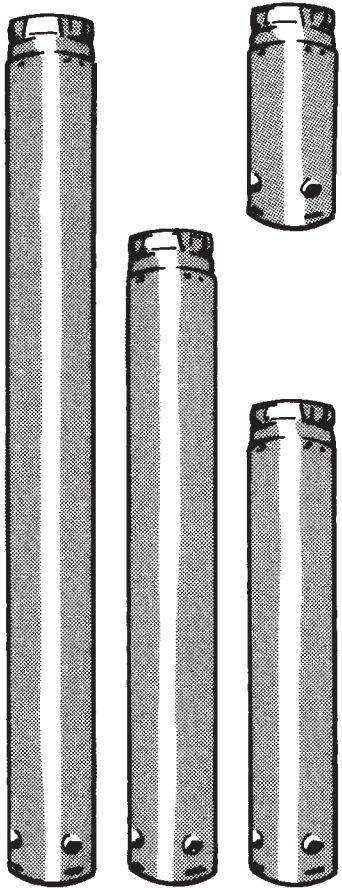
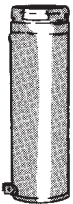
Please note: Sizes over 300mm dia and up to 600mm dia in pipe fittings and cowls are made to order. All items shown are ex stock.

ROUND PIPE		CODE	ACTUAL LENGTH (mm)	INSTALLED LENGTH (mm)	INSIDE DIA (mm)	OUTSIDE DIA (mm)
	75mm	2000	1525	1490	76	92
		2001	1219	1180	76	92
		2002	914	875	76	92
		2003	305	270	76	92
		2004	610	575	76	92
	100mm	2007	1525	1490	101	117
		2008	1219	1180	101	117
		2009	914	875	101	117
		2010	305	270	101	117
		2011	610	575	101	117
	125mm	2014	1525	1490	127	143
		2015	1219	1180	127	143
		2016	914	875	127	143
		2017	305	270	127	143
		2250	610	575	127	143
	150mm	2021	1525	1490	152	168
		2022	1219	1180	152	168
		2023	914	875	152	168
		2024	305	270	152	168
		2251	610	575	152	168
200mm	2020	1525	1490	203	220	
	2025	914	875	203	220	
	3308	305	270	203	220	
250mm	2026	914	875	254	280	
	3309	455	415	254	280	
300mm	3302	914	875	305	330	
	3310	455	415	254	330	
ADJUSTABLE PIPE		CODE				
	2028	305	VARIABLE	76	92	
	2029	305	VARIABLE	101	117	
	2030	305	VARIABLE	127	143	
	2031	305	VARIABLE	152	168	
	2032	305	VARIABLE	203	220	
	2033	305	VARIABLE	254	280	
	3301	450	VARIABLE	305	330	
CAN BE USED AS A 300mm LENGTH OR SLID OVER ANOTHER PIPE TO GIVE A VARIABLE LENGTH						
DIVERTOR CONNECTOR		CODE				
	2049	100	50 APPROX	75	91	
	2050	100	50 APPROX	100	116	
	2051	100	50 APPROX	125	142	
	2052	100	50 APPROX	150	167	
	2053	100	50 APPROX	201	218	
	2054	125	60 APPROX	252	278	
	3307	125	60 APPROX	303	328	
USE IN CONJUNCTION WITH AN ADJUSTABLE PIPE TO GIVE A MEANS OF DISCONNECTING APPLIANCE WITHOUT DISTURBING THE FLUE						

SPECIFICATIONS & DIMENSIONS FOR
ROUND TWIN SKIN GAS FLUE

Manufactured with an aluminium inner pipe and a galvanised outer pipe - all diameters are inside dimensions

Round pipe and fittings use the simple 'push-twist-lock' principle.

Please note: Sizes over 300mm dia and up to 600mm dia in pipe fittings and cowls are made to order. All items shown are ex stock.

90° ADJUSTABLE ELBOW

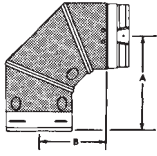

CODE	DIA.	A (mm)	B (mm)
2035	75	140	100
2036	100	171	133
2037	125	184	146
2038	150	190	152
2039	200	228	178
2040	255	254	203

45° ADJUSTABLE ELBOW

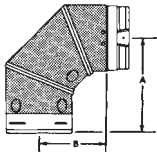

CODE	DIA.	A (mm)	B (mm)
2042	75	95	50
2043	100	95	50
2044	125	85	64
2045	150	100	75
2046	200	140	100
2047	250	155	111
3305	300	171	117

GAS COWLS

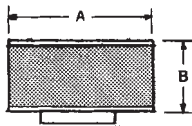

CODE	DIA.	A (mm)	B (mm)
2056	75	180	52
2057	100	180	52
2058	125	225	60
2059	150	272	90
2063	200	360	115
2064	250	450	145
3306	300	540	172

SOLID BRICK WALL ELBOW

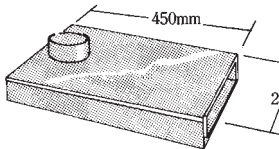

CODE
1983

FOR INSTALLING FLUE FROM SPACE HEATER ONTO EXTERIOR WALL
(BRICK CAVITY OR WEATHER BOARD) SIMPLY CUT TO
REQUIRED LENGTH.

CEILING RINGS

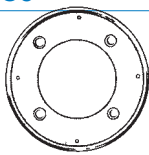

CODE	NOMINAL SIZE	INSIDE DIA.	OUTSIDE DIA
2301	75	92	
2302	100	117	
2303	125	143	
2304	150	168	
2306	200	220	
2308	250	280	
2310	300	330	

TEE CODE

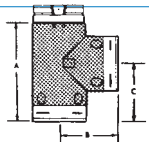

DIA (mm)	A	B		
2080	75	216	127	127
2081	100	241	140	140
2082	125	266	152	152
2083	150	292	165	165
2084	200	330	197	197
2085	250	362	228	216
3304	300	457	254	260

INCREASER



CODE	DIA (mm)	A
2090	75 to 100	133
2091	75 to 125	133
2092	75 to 150	133
2093	100 to 125	133
2094	100 to 150	133
2095	125 to 150	133
2096	150 to 200	159
2097	175 to 200	159
2098	200 to 250	159
3303	250 to 300	159

**SPECIFICATIONS & DIMENSIONS FOR
OVAL TWIN SKIN GAS FLUE**

Manufactured with an aluminium inner pipe and a galvanised outer pipe.

Oval pipe is equivalent to 10mm round pipe.

Oval pipe and fittings use the simple 'push-twist-lock' principle.

OVAL PIPE

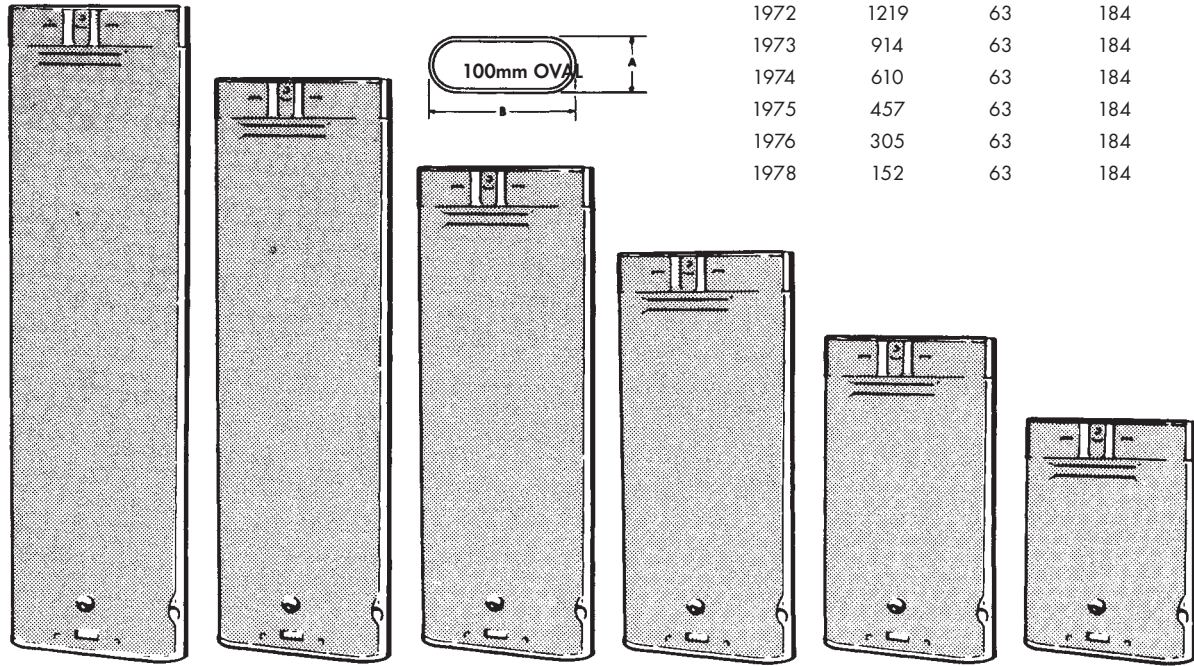

CODE	LENGTH (mm)	A (mm)	B (mm)
1971	1525	63	184
1972	1219	63	184
1973	914	63	184
1974	610	63	184
1975	457	63	184
1976	305	63	184
1978	152	63	184

ADJUSTABLE PIPE

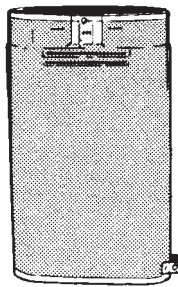

CODE	ACTUAL LENGTH (mm)	INSTALLED LENGTH
1977	305	VARIABLE

ELBOW HOUSING

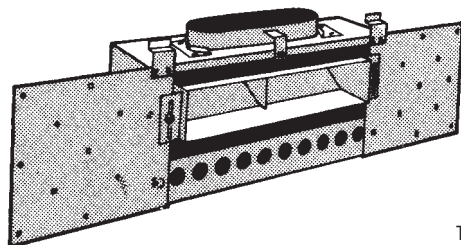

CODE
1982

TO BE USED WHEN INSTALLING A CONSOLE OR SPACE HEATER IN STUD WALLS OF 90mm OR GREATER. (REFER TO PAGE 5 FOR INSTALLATION INSTRUCTIONS.)

OVAL TEES

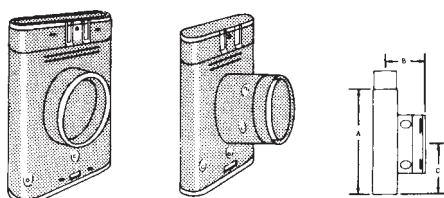

		A	B	C
SHORT	2086	216	50	127
LONG	2087	216	120	127

SPECIFICATIONS & DIMENSIONS FOR
ABEY OVAL TWIN SKIN GAS FLUE

Manufactured with an aluminium inner pipe and a galvanised outer pipe.

Oval pipe is equivalent to 10mm round pipe.

Oval pipe and fittings use the simple 'push-twist-lock' principle.

45° ELBOWS

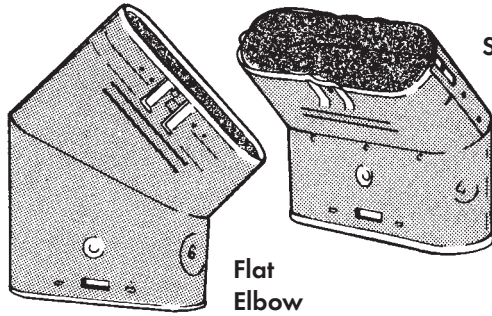

Standard Elbow

Flat Elbow

	CODE	A (mm)	B (mm)	CODE	A (mm)	B (mm)	
45° ELBOW (STANDARD)	1980	92	54	45° ELBOW (FLAT)	1981	105	79

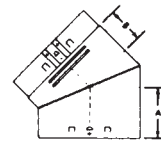
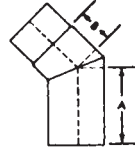

OVAL/ROUND ADAPTOR

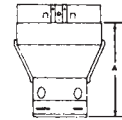
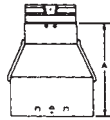
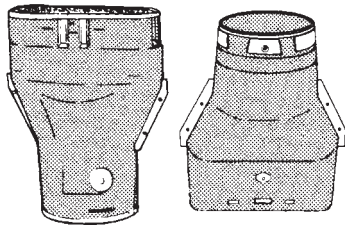

	CODE	A (mm)
OVAL/ROUND	1985	197
ROUND/OVAL	1992	197

SPIGOT ADAPTOR

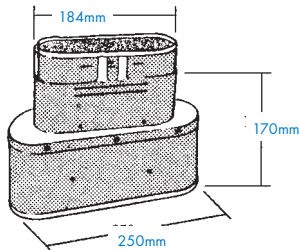

CODE
1989

ADAPTS ALL WALL FURNACES TO SUIT OVAL TWIN SKIN

HEADER PLATE

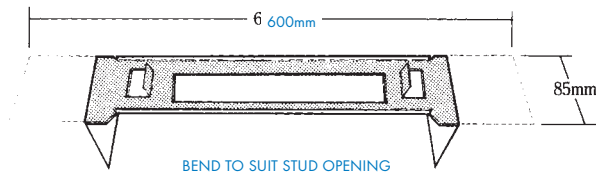

CODE
1990

ATTACH ABOVE WALL FURNACE TO SUPPORT & LOCATE THE DUAL FLUE CENTRAL IN STUD WALL

TOP PLATE SPACER

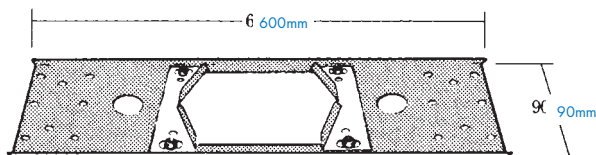

CODE
1986

SECURES TO TOP PLATE LOCATES FLUE CENTRAL INSIDE STUD WALL GIVING CORRECT CLEARANCE



TECHNICAL ENQUIRIES 1800 652 563



**PLUMBING
INDUSTRY
COMMISSION**

TOLL FREE: 1800 015 129

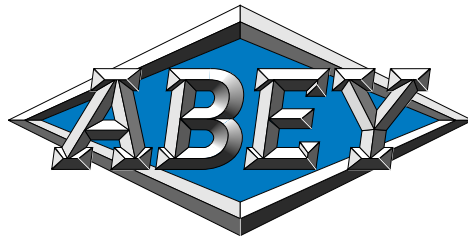

The Tradesman's Choice

VICTORIA Abey, Head Office, 57-81 Abey Road, Melton, 3337 Tel: (03) 9747 7777 Fax: (03) 9747 7700

NEW SOUTH WALES Abey, 45 Prime Drive, Seven Hills, 2147 Tel: (02) 9838 8944 Fax: (02) 9838 9003

QUEENSLAND Abey, 36 Nestor Drive, Meadowbrook, 4131 Tel: (07) 3805 7000 Fax: (07) 3805 7111

SOUTH AUSTRALIA Mike North (SA) Pty Ltd, 10 Denis Street, St Marys, 5042 Tel: (08) 8374 3044 Fax: (08) 8374 3032

WESTERN AUSTRALIA Abey, Unit 1, 8 Leeway Court, Osborne Park, 6017 Tel: (08) 9446 8255 Fax: (08) 9446 7770

TASMANIA Crisp Ikin Agencies, 7 Pear Avenue, Derwent Park, 7009 Tel: (03) 6272 7386 Fax: (03) 6272 7806

ABEY AUSTRALIA – A WHOLLY AUSTRALIAN OWNED COMPANY

Abey Australia Pty Ltd ABN 34004 589 879